

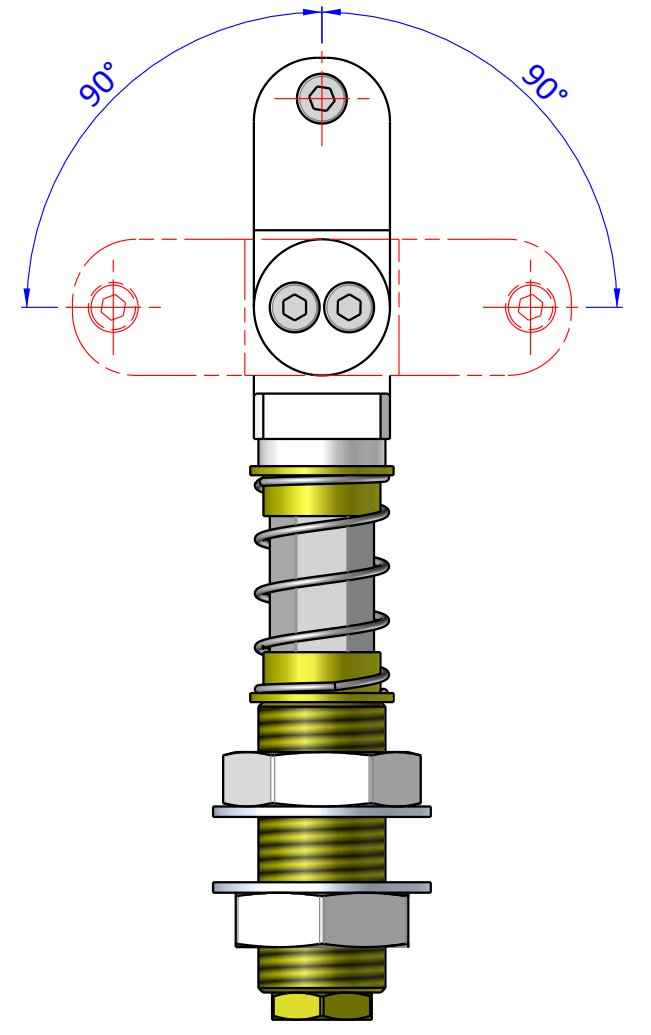

THE PROPERTY OF THE DRAWING IS ESTABLISHED BY LAW. IT IS FORBIDDEN TO PRODUCE OR SHOW IT TO THIRD PART. WITHOUT A WRITTEN AGREEMENT.

Item	Name	Q.ty
1	05.01.001.06	2
2	GVR.10.2	1
3	GVR.10.3	1
4	M.15x35	1
5	R.3.SCH	3
6	R.14.SCH	2
7	SAE.14181815.2	1
8	SAE.14181815.4	2
9	SAE.14181815.5	1
10	SAEG.14181815.3	1
11	SAM.1410.1	1
12	V.TCE3x16	3

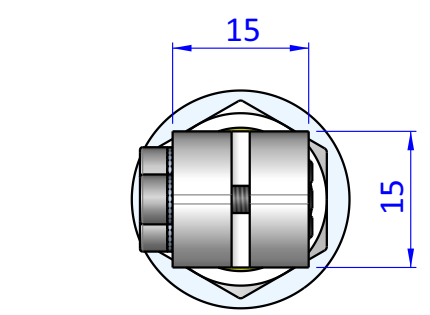
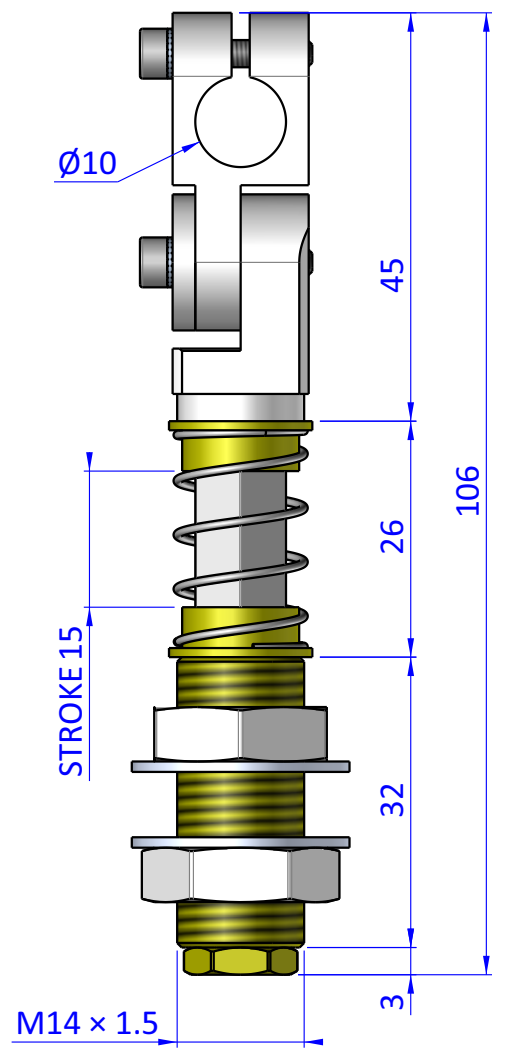
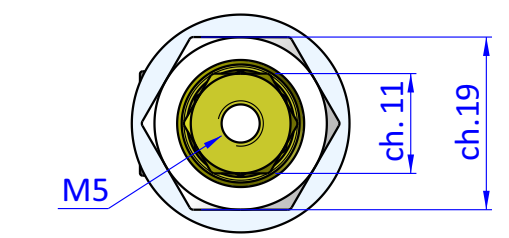
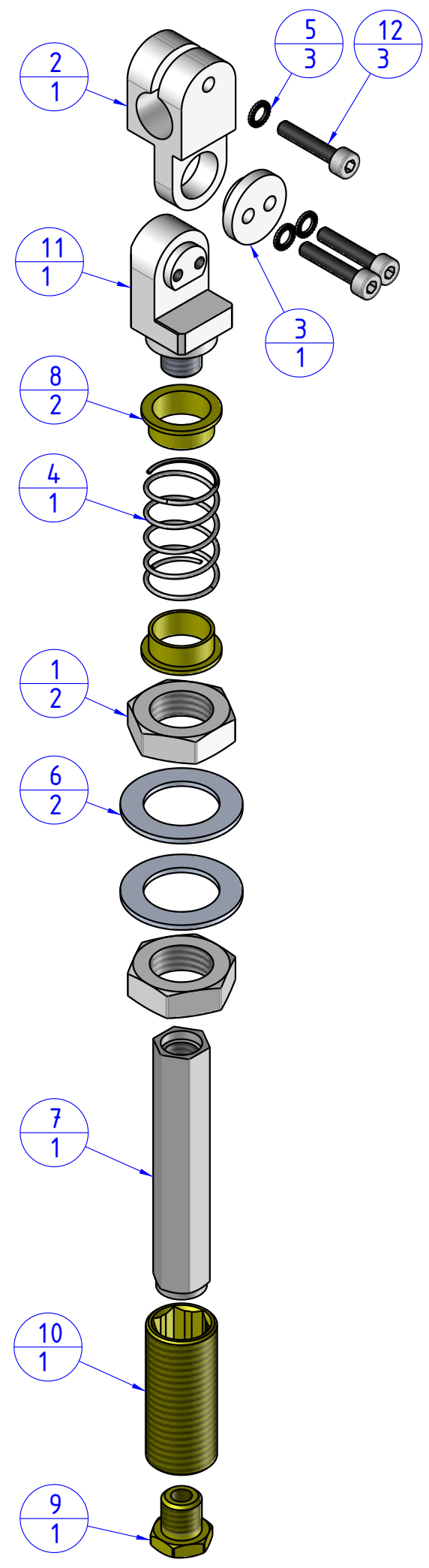

Format A3
UNI 936-76

 FPS FPSERVICES AUTOMATION		DESIGNED FROM		REVIEW
		FPS Automation		A
GENERAL TOLERANCE		DATE	WEIGHT	
UNI - ISO 2768		24/01/2022	0,069kg	
CLASSE f		DESCRIPTION	CODE	
		CA.SAMG.141510	CA.SAMG.141510	